

STEREO INTEGRATED AMPLIFIER

KA-770D



INSTRUCTION MANUAL

KENWOOD

FILE

© PRINTED IN JAPAN B50-6947-00K,P,U,M,UE,X,E,TXT
88/12 11 10 9 8 7 6 5 4 3 2 1 87/12 11 10 9 8 7 6

Rear panel safety precautions

<p>CAUTION RISK OF ELECTRIC SHOCK DO NOT OPEN</p>	<p>CAUTION: TO REDUCE THE RISK OF ELECTRIC SHOCK, DO NOT REMOVE COVER (OR BACK). NO USER-SERVICEABLE PARTS INSIDE. REFER SERVICING TO QUALIFIED SERVICE PERSONNEL.</p>
	<p>The lightning flash with arrowhead symbol, within an equilateral triangle, is intended to alert the user to the presence of uninsulated "dangerous voltage" within the product's enclosure that may be of sufficient magnitude to constitute a risk of electric shock to persons</p>
	<p>The exclamation point within an equilateral triangle is intended to alert the user to the presence of important operating and maintenance (servicing) instructions in the literature accompanying the appliance</p>

For your records

Record the serial number, found on the back of the unit, in the spaces designated on the warranty card, and in the space provided below. Refer to the model and serial numbers whenever you call upon your dealer for information or service on this product.

Model _____ Serial Number _____

Unpacking

Unpack the unit carefully and make sure that all accessories are put aside so they will not be lost.

Examine the unit for any possibility of shipping damage. If your unit is damaged or fails to operate, notify your dealer immediately. If your unit was shipped to you directly, notify the shipping company without delay. Only the consignee (the person or company receiving the unit) can file a claim against the carrier for shipping damage.

We recommend that you retain the original carton and packing materials for use should you transport or ship the unit in the future.

Before applying power

Important!

U.S.A., Canada, Australia, U.K. and Europe

These units are not equipped with an AC voltage selector switch and the discussion of such a switch that follows should be disregarded.

All other countries

Units shipped to countries other than above countries are equipped with an AC voltage selector switch on the rear panel. Refer to the following paragraph for the proper setting of this switch.

AC voltage selection

This unit operates on 120 volts or 220-240 volts AC. The AC voltage selector switch on the rear panel is set to the voltage that prevails in the area to which the unit is shipped. Before connecting the power cord to your AC outlet, make sure that the setting position of this switch matches your line voltage. If not, it must be set to your voltage in accordance with the following direction:

Note:

Our warranty does not cover damage caused by excessive line voltage due to improper setting of the AC voltage selector switch.

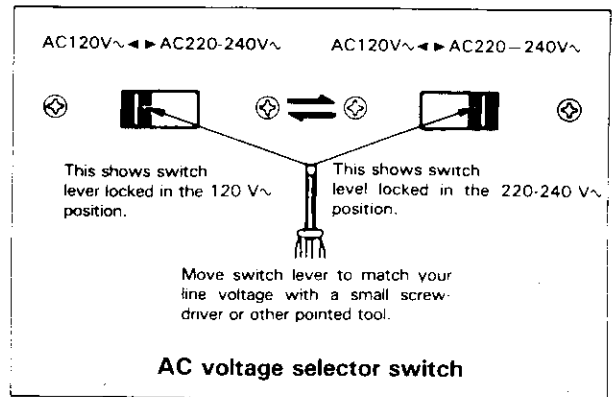

For United Kingdom

The mains plug must be removed from the wall socket prior to any internal examination.

Important

The wires in this mains lead are coloured in accordance with the following code:

Blue Neutral
Brown Live

The wires in this mains lead must be connected to the terminals in the plug as follows:

Wire Colour	Plug Terminal Marking
Blue	N or Black
Brown	L or Red

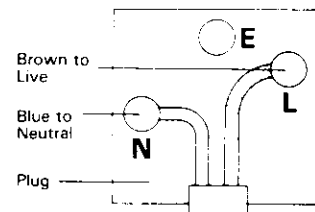

Notes:

- 1) If a 13-amp plug is used, this must be fitted with a 5-amp fuse.
- 2) If a 3-pin plug with earthing contact is used, no wire must be connected to the E terminal.

WARNING:

TO PREVENT FIRE OR ELECTRIC SHOCK, DO NOT EXPOSE THIS APPLIANCE TO RAIN OR MOISTURE.

Safety precaution for AC plug (For USA and Canada)

CAUTION: TO PREVENT ELECTRIC SHOCK DO NOT USE THIS (POLARIZED) PLUG WITH AN EXTENSION CORD, RECEPTACLE OR OTHER OUTLET UNLESS THE BLADES CAN BE FULLY INSERTED TO PREVENT BLADE EXPOSURE

Before operation

Notes on installation

Do not place the unit in a place which is exposed to direct sunlight, near a heating appliance, etc.

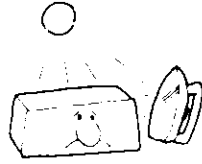

Do not place a vase containing water, makeup, etc. on the unit. Do not use in a humid place.

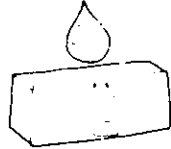

To maintain good ventilation, do not put records or a tablecloth on the unit. Place the unit at least 10 cm away from the walls.



Choose a location that is relatively free from vibration or excessive dust.

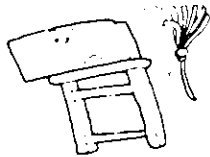

The unit may not function properly if used at extremely low, or freezing temperatures.



Safety precautions

Never remove the case. If the internal parts are touched, accidentally, a serious electric shock might occur.

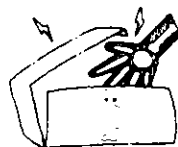

Never touch internal parts.

If a metal object, such as a hair pin or a needle, comes into contact with the power socket on the rear panel, a dangerous electric shock may result. For families with children, never permit children to put anything, especially metal, inside this unit.



Touching the power plug when your hands are wet may result in a serious electric shock.

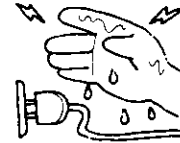

Never touch with wet hands.

Never pull, bend or extend the power cord. This could damage the power cord, resulting in a broken cord or short-circuit.

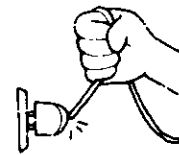

Always grasp the plug.

In case of abnormal smell

If an abnormal smell or smoke is detected, immediately turn the power OFF and pull out the power cord. Contact your dealer or nearest Service Station.

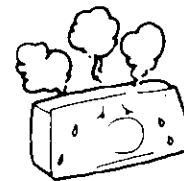

Cleaning

Do not use volatile solvents such as alcohol, paint thinner, gasoline, benzine, etc. to clean the cabinet. Use a silicone cloth or a clean dry cloth.

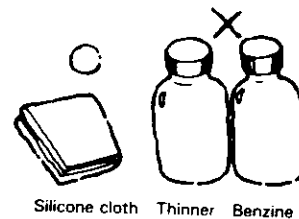

Silicone cloth Thinner Benzine

System connections

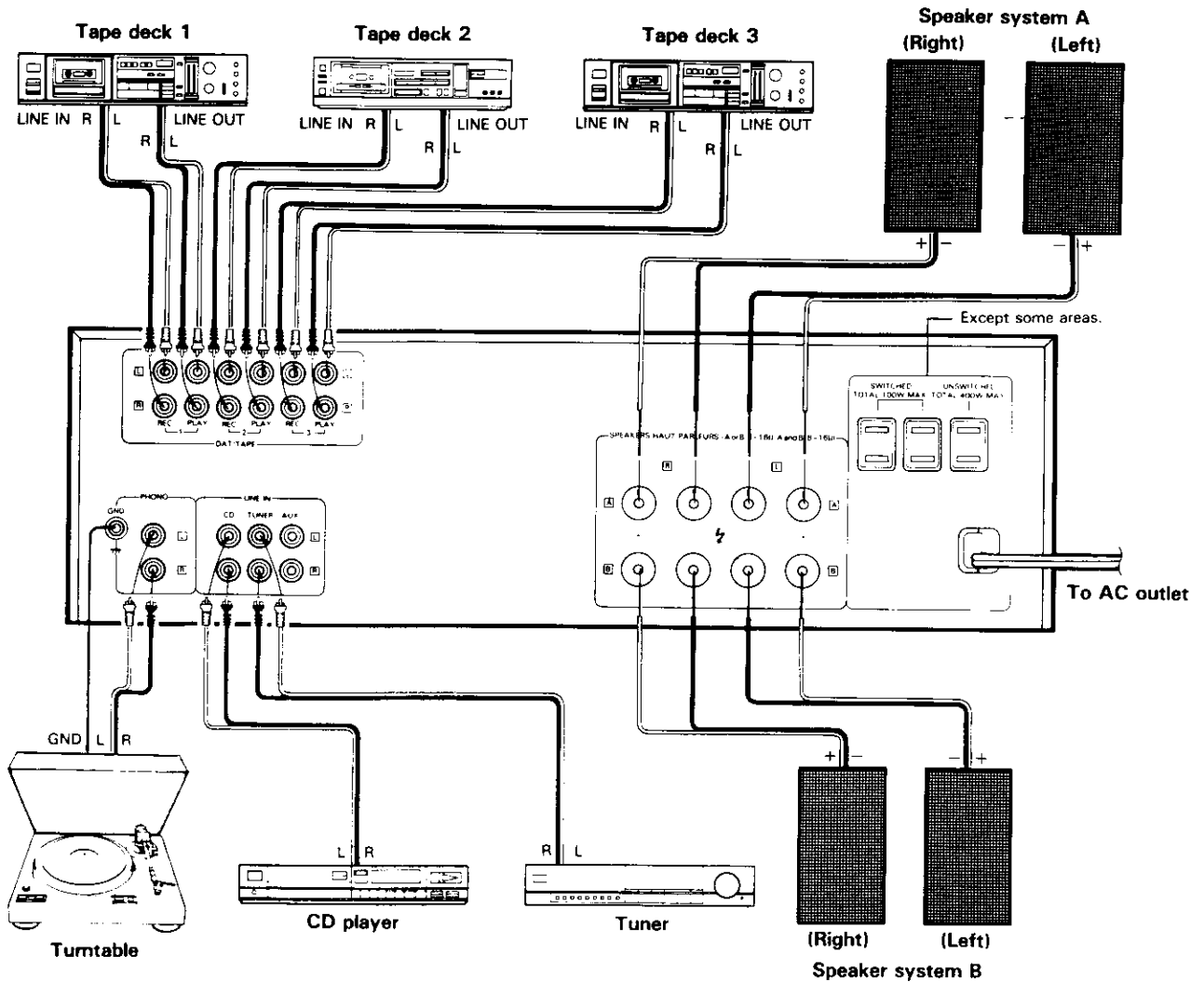

Connection of speaker system

- Two sets of speaker systems, A and B, can be used simultaneously. Connect the left speakers to the SPEAKERS □ terminals and right speakers to the □ terminals. Be sure to respect the (+) and (-) polarities.

If the connection is made with reversed polarity, it will lead to the degraded stereo effect with ambiguous sound image lacking something at the center.

Notes:

- Before connecting the speaker cables, be sure to turn the POWER switch OFF.
- Check that no lead wire is in contact with other terminals.

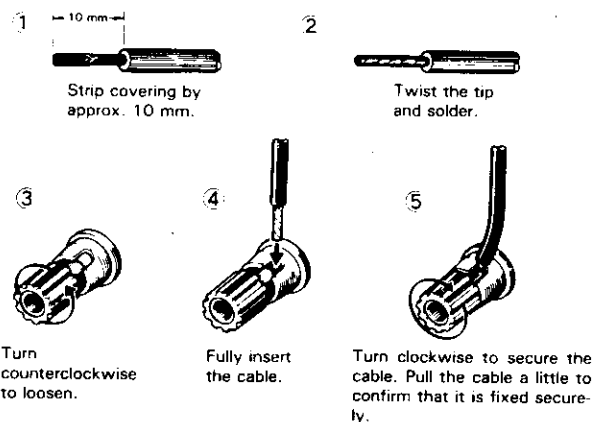

Connection of speaker cable

- **Speaker impedance**

When connecting only to either the A or B SPEAKERS terminals, use speakers with an impedance from 4 to 16 ohms.

When connecting to both the A and B SPEAKERS terminals for playing two pairs of speakers simultaneously by setting the SPEAKERS switch to "A + B", use speakers with an impedance from 8 to 16 ohms.

Note:

Connect only one speaker to one set of SPEAKERS terminals. If more than one speaker cable is connected to a terminal, this could cause the amplifier to malfunction.

Connection of turntable

- Connect the turntable's output cable to this unit's PHONO terminals. Make sure of the **L** (Left) and **R** (Right) connections.
- Connect the turntable's grounding cable to this unit's GND terminal.

Connection of tuner

Connect the output terminals of the tuner to the TUNER terminals of this unit using RCA pin-plug cords (connection cords with RCA pin-plugs at both ends) confirming the L-channel and R-channel terminals connected correctly.

Connection of CD player

Connect the CD player's output terminals to this unit's CD terminals using a RCA pin-plug cord. Make sure of the **L** and **R** connections.

Connection of AUX jack

Examples of equipment that can be connected to the AUX jacks are: another tuner for compared listening, a tape recorder to be used exclusively for playback, the audio output from a video recorder, TV tuner, etc.

Connect the AUX jacks of this unit to the output jacks of the unit with an RCA pin-plug cords confirming the L-ch and R-ch terminals connected correctly.

Connection of GND terminal

Use the GND terminal for grounding the turntable, tape deck, etc. connected.

Connection of DAT/TAPE jacks

This unit has three input systems for Digital Audio Tape recorders or ordinary tape recorders.

When using three tape recorders, connect them to jacks 1, 2 and 3. These jacks also accept the connection of the audio output jacks of Hi-Fi video recorders. (Do not connect with video output jacks.)

- **Connection for recording:**

Connect the REC jacks to the tape deck's recording input (LINE IN) jacks using RCA pin-plug cords. Make sure to the left **L** and right **R** connections.

- **Connection for playback:**

Connect the PLAY jacks to the tape deck's playback output (LINE OUT) jacks using RCA pin-plug cords. Make sure of the left **L** and right **R** connections.

AC outlets (Except some areas)

The AC outlets on the rear panel of the unit may be used to supply power to other components in the system, such as turntables, tape decks, etc. Never connect equipment whose power consumption exceeds the maximum value shown at each outlet.

1. SWITCHED outlets: These outlets supply power only when the unit is turned on. The maximum total capacity (both outlets) is 100 watts.

2. UNSWITCHED outlet: This outlet provide power when the unit is plugged into an active AC wall outlet, regardless of the setting of the POWER switch. The maximum capacity is 400 watts.

Controls and indicators

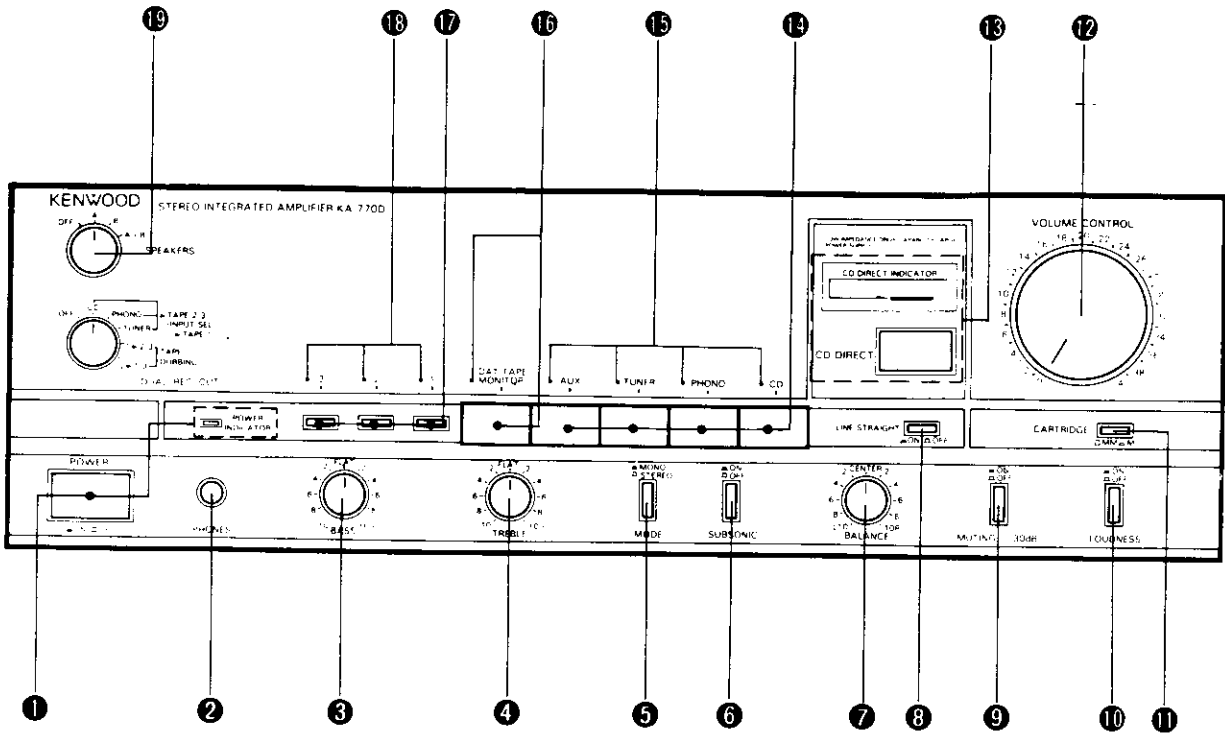

1 POWER switch/indicator (POWER INDICATOR)

Press the switch to turn power ON. The POWER INDICATOR lights up. Pressing the switch again turns the power OFF.

2 Headphones jack (PHONES)

Connect the plug of stereo headphones. When listening to the sound only through headphones, set the SPEAKERS switch to "OFF".

3 BASS control

Turning the knob clockwise enhances low frequencies and turning it counterclockwise attenuates them. When the control is at the center "FLAT" position, the frequency characteristic becomes flat.

4 TREBLE control

Turning the knob clockwise enhances high frequencies and turning it counterclockwise attenuates them. When the control is at the center "FLAT" position, the frequency characteristic becomes flat.

5 MODE switch

STEREO: Set when playing sound in stereo.

MONO: Set when playing sound in monaural. Use this position also for checking stereo phases of stereo balance.

6 SUBSONIC filter switch

ON: With this position, low frequencies of 18 Hz or less are eliminated by 6 dB per one octave. Use this position to eliminate low-frequency noise out of the audible range due to warp of disk or the contact of the stylus and disk.

OFF: With this position, the use of capacitor is eliminated throughout the signal circuitry from the input terminals to the speaker output terminals. This makes the frequency characteristic flat, and is useful for reproduction of very low frequencies.

7 BALANCE control

Adjust the left and right sound balance of speakers and headphones. Turning the control counterclockwise decreases the right sound level and turning it clockwise decreases the left sound level.

8 LINE STRAIGHT switch

ON: The switch is ON. The signal then bypasses the tone control circuitry, so the tone cannot be controlled but the frequency characteristics become flat.

OFF: The tone can be controlled using the BASS and TREBLE controls.

9 MUTING switch

When this switch is pressed, the overall sound level can be decreased by -30 dB so the volume can be reduced.

The MUTING switch is convenient for listening in low level, because the volume control becomes more delicate when the switch is ON.

10 LOUDNESS switch

Human ears become less sensitive to low frequencies when the sound level is low.

11 CARTRIDGE select switch

Set the switch according to the cartridge of the turntable used. Press the switch in when the cartridge used is MC (Moving Coil) type. Even when an MC cartridge is used, set the switch to the out position when the cartridge has high output level.

12 VOLUME CONTROL

This controls the sound level of the speakers and headphones. The volumes of both the left and right channels are adjusted simultaneously. No sound is produced when the knob is turned fully counter-clockwise, and turning the knob clockwise gradually increases the volume.

13 CD DIRECT selector switch and indicator (CD DIRECT INDICATOR)

When this switch is set to ON (the indicator lights), the signal applied to the CD jacks is selected and high quality sound is heard from the speakers. In this setting, controls other than the VOLUME CONTROL, BASS and TREBLE controls, MUTING switch and LOUDNESS switch do not function. When this switch is set to OFF, the source sound selected by input selector is heard from the speakers. Even when a tuner is connected instead of the CD player, high quality sound is obtained.

Note

When this switch is set to ON, the sound sources (PHONO, TAPE, AUX) cannot be heard from the speakers. To listen to the sound sources, set the switch to OFF.

14 Input selector switches (CD/PHONO/TUNER/AUX)

CD: Press to listen to the sound from the CD player connected to the CD input terminals.

PHONO: Press to listen to the sound from the turntable connected to the PHONO input terminals.

TUNER: Press to listen to the sound from the tuner connected to the TUNER input terminals.

AUX: Press to listen to the sound from the equipment connected to the AUX terminals.

Note:

When all the input selector switches are OFF, none of the selected input indicators (CD PHONO TUNER AUX) is lit indicating the abnormal condition. In this case, press a desired input selector switch so that the corresponding indicator lights.

15 Input selector indicators

The indicator corresponding to the input selector switch depressed lights.

16 DAT/TAPE MONITOR switch and indicator

This switches the input between the equipment selected with the input selector switches and that selected with the tape selector switches.

When the switch is depressed, the DAT/TAPE MONITOR indicator above lights and the signal from the equipment selected with the tape selector switches (1, 2, 3) is input. When the switch is pressed again, the DAT/TAPE MONITOR indicator goes off and the signal from the equipment selected with the input selector switches (AUX/TUNER/CD/PHONO) is input.

(Although record play and radio broadcast cannot be listened to when the DAT/TAPE MONITOR indicator is lit, the sound from the equipment connected to the CD input jacks can be played by pressing the CD DIRECT switch, which has priority over other switches.)

17 Tape selector switches (1/2/3)

After pressing the DAT/TAPE MONITOR switch, press one of the switches to select the tape input.

18 Tape selector indicators

When one of switches 1, 2 and 3 below is depressed, the indicator lights to indicate that the corresponding set of DAT/TAPE jacks is selected.

19 Speaker select switch (SPEAKERS)

OFF: Set for listening sound only through headphones. No sound will be heard from the speakers.

A: Set for listening sound through the speaker system connected to the SPEAKERS A terminals.

B: Set for listening sound through the speaker system connected to the SPEAKERS B terminals.

A + B: Set for listening sound through both of the speakers systems connected to the SPEAKERS A and B terminals.

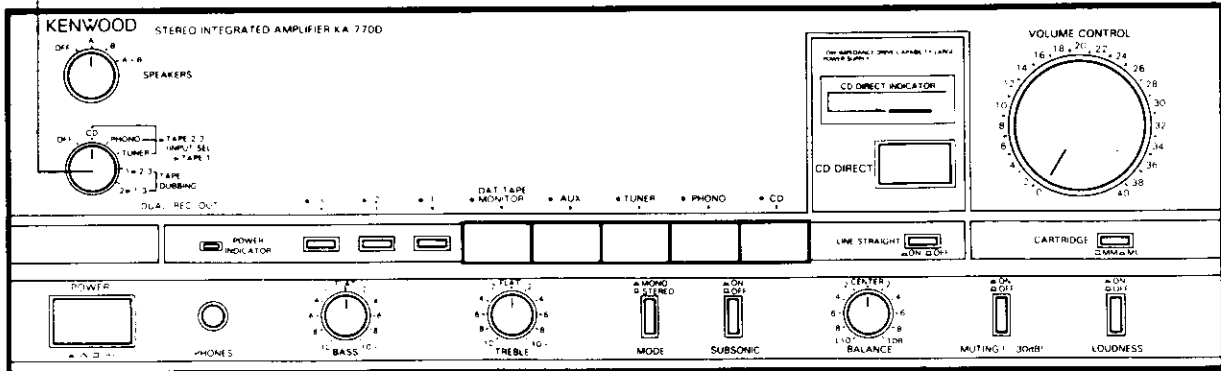

20 DUAL REC OUT switch

This switch is used in recording or dubbing operations.

OFF: The DAT/TAPE 1/2/3 REC jacks on the rear panel output no signal. Because the tape deck connections are cut off, this position allows enjoyment of high-quality sound without the interference from impedances of the tape decks.

CD, PHONO, TUNER: With any of these positions, the tape recorder connected to DAT/TAPE 1 jacks on the rear panel can record the sound of equipment selected by the input selector switches.

The tape recorders connected to DAT/TAPE 2 and 3 jacks can record the sound of equipment selected by the PHONO, CD or TUNER jacks depending on the position of this switch.

TAPE DUBBING 1 ▶ 2/3: Set to this position when playing the tape deck connected to the rear-panel DAT/TAPE 1 jacks and recording the sound of tape deck(s) connected to DAT/TAPE 2 or (and) 3 jacks.

TAPE DUBBING 2 ▶ 1/3: Set to this position when playing the tape deck connected to the rear-panel DAT/TAPE 2 jacks and recording the sound of tape deck(s) connected to DAT/TAPE 1 or (and) 3 jacks.

Operating instructions

* Before turning the power ON, be sure to set the VOLUME CONTROL to the fully counterclockwise position.

* Operate in the order of the numbers.

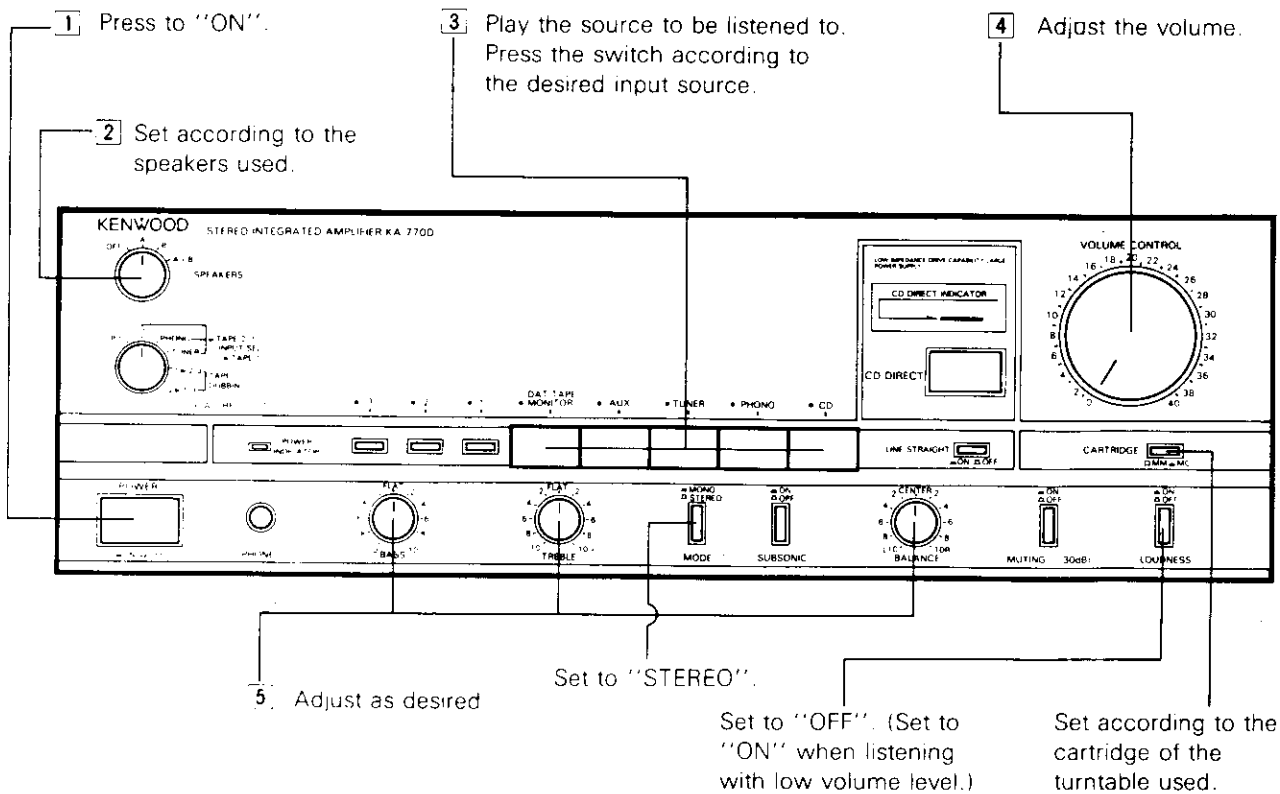

Listening to CD player play

1. Press the CD input selector switch or the CD DIRECT switch. (The corresponding indicator lights.)
2. Operate the CD player connected to the CD input terminals.
3. Adjust the tone (BASS TREBLE controls) and volume (VOLUME CONTROL).

Listening to radio broadcast

1. Press the TUNER input selector switch. (The TUNER indicator lights.)
2. Operate the tuner to receive a broadcast.
3. Adjust the tone and volume.

Listening to record play

1. Press the PHONO input selector switch. (The PHONO indicator lights.)
2. Set the CARTRIDGE switch according to the cartridge used.
3. Operate the turntable.
4. Adjust the tone and volume.

Note:

Before replacing the cartridge or placing the stylus on the record, it is recommended to decrease the sound level by pressing the MUTING switch, or turning the VOLUME CONTROL counterclockwise in order to protect speakers.

Operating the equipment connected to the AUX terminals

1. Press the AUX input selector switch. (The AUX indicator lights.)
2. Operate the equipment connected to the AUX terminals selected.
3. Adjust the tone and volume.

Tape deck operation

This unit is equipped with three sets of DAT/TAPE jacks (DAT/TAPE 1, DAT/TAPE 2, DAT/TAPE 3). By connecting three tape decks, recording, playback and dubbing between tapes are possible.

• Playback procedure

1. After connecting tape decks to the DAT/TAPE 1, DAT/TAPE 2 and DAT/TAPE 3 jacks on the rear panel, first press the DAT/TAPE MONITOR switch, then press one of the 1, 2 and 3 tape switches.
2. Operate the tape deck selected to play a prerecorded tape.

3. Adjust the tone and volume.

Other audio equipment, such as DATs (Digital Audio Tape recorders) and audio output from a Hi-Fi video recorder, can also be played with the same procedure. For details, refer to the instructions provided with the DAT recorder or Hi-Fi video recorder.

• **Recording on the tape deck connected to the DAT/TAPE 1 jacks**

1. Press one of the input selector switches (PHONO, CD, TUNER, AUX) corresponding to the source to be recorded.
2. Set the DUAL REC OUT switch to either PHONO, CD or TUNER (any one of these positions).
3. Operate the tape deck to enter the record mode.
4. The recording level should be adjusted by the recording level control of the tape deck. The VOLUME CONTROL of this unit does not affect the recording level.

• **Recording on the tape deck(s) connected to the DAT/TAPE 2/3 jacks**

1. The input selector switch can be set to any source. (It is recommended to select the source to be recorded on the tape deck connected to the DAT/TAPE 1 jacks or the source to be listened to while recording.)
2. Set the DUAL REC OUT switch for the source to be recorded, CD, PHONO or TUNER.
3. Operate the tape deck(s) to enter the record mode. (Either recording only on the tape deck connected to DAT/TAPE 2 or 3 or simultaneous recording on two tape decks is possible.)
4. Adjust the recording level with the recording level control(s) on the tape deck(s). The VOLUME CONTROL of this unit does not affect the recording level. The sound from this unit can also be recorded on DAT recorders or Hi-Fi video recorders. (For details, refer to the instructions provided with the DAT recorders and Hi-Fi video recorders.)

• **Checking the recording condition (Record monitoring)**

When the recording tape deck has three heads (independent record, play and erase heads), the recorded sound can be checked by pressing the DAT/TAPE MONITOR switch and, with the indicator lit, pressing 1, 2 or 3 tape switch of the desired deck. The sound which has just been recorded on tape can be checked through the speakers.

Note:

For record monitoring, the tape deck must be connected to both the REC and PLAY jacks. Record monitoring is not available with tape decks using a two-head system.

• **Dubbing from tape deck 1 to tape deck(s) 2/3**

1. Set the DUAL REC OUT switch to "1 ▶ 2/3".
2. Set tape deck 1 to the play mode and tape deck(s) 2/3 to the record mode.
3. Adjust the recording level of the tape deck(s).

• **Dubbing from tape deck 2 to tape deck(s) 1/3**

1. Set the DUAL REC OUT switch to "2 ▶ 1/3".
2. Set tape deck 2 to the play mode and tape deck(s) 1/3 to the record mode.
3. Adjust the recording level of the tape deck(s).

Operation of DUAL REC OUT switch

The DUAL REC OUT switch allows assignment of two different recording sources to tape deck 1 and tape decks 2/3. The dubbing facility also enables the following operations.

• **Listening to an other source while dubbing between tape decks**

1. Start dubbing with the DUAL REC OUT switch set to "1 ▶ 2/3" or "2 ▶ 1/3".
2. Press the input selector switch (PHONO, CD, TUNER or AUX) of the source to be heard.
3. Play the selected source equipment connected to the PHONO, CD, TUNER, AUX jacks.
4. Adjust the tone and volume.

• **Recording FM broadcast while listening to record play**

1. Use tape deck 2 or 3 for recording.
2. Press the PHONO input selector switch so that the record play can be heard.
3. Set the DUAL REC OUT switch to "TUNER" and tune an FM station on the tuner.
4. Start recording the FM broadcast on the tape deck. Adjust the recording level with the recording level control of the tape deck.
5. To switch from record play to FM broadcast, press the TUNER input selector switch. The FM broadcast recording continues even after this time.

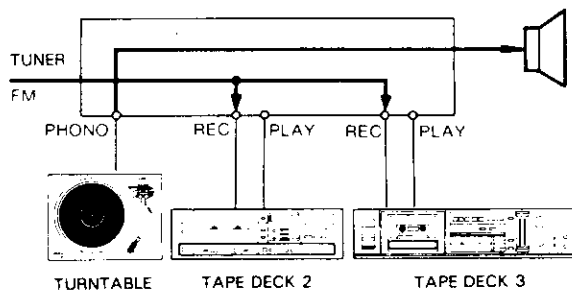

6. This function is also valid with combinations other than record and FM broadcast.

• **Recording CD play at the same time as recording and listening to record play**

1. Use tape deck 1 for recording record play, and tape deck 2 or 3 for recording CD play.
2. Press the PHONO input selector switch so that the record play can be heard.
3. Set the DUAL REC OUT switch to "CD" and play a CD.
4. Put tape deck 1 to the record mode.
5. Tape deck 1 starts recording the record play.
6. Put tape deck 2 or 3 to the record mode.
7. Tape deck 2 or 3 starts recording the CD play.
8. To listen to the CD play, press the DAT/TAPE MONITOR switch then 2 or 3 tape switch.

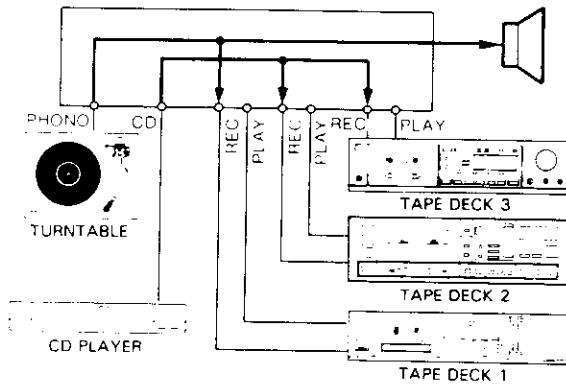

⑨ This function is also valid with combinations other than turntable and CD player.

Various operations provided by the combination of DUAL REC OUT and input selector switches

The functions of the DAT/TAPE REC jacks of this unit are basically different for jack 1 and jacks 2 and 3. Basically, REC 1 jacks output the signal from the source selected by the input selector switches, and REC 2 and REC 3 jacks output signals from the source selected by the DUAL REC OUT switch. The following table shows the outputs provided by different settings of the switches.

DUAL REC OUT SW Position \ DAT/TAPE REC Jacks	REC 1	REC 2	REC 3
OFF	---	---	---
PHONO	SOURCE	PHONO	PHONO
CD	SOURCE	CD	CD
TUNER	SOURCE	TUNER	TUNER
1 ▶ 2/3	SOURCE	TAPE 1	TAPE 1
2 ▶ 1/3	TAPE 2	SOURCE	TAPE 2

Note: "SOURCE" refers to the source selected by the input selector switches (CD/PHONO/TUNER/AUX).

< **Examples** >

(For operation, set switches as shown in the illustrations.)

• **Listening to record play and recording it on tape deck 1 as well as on tape decks 2 and 3**

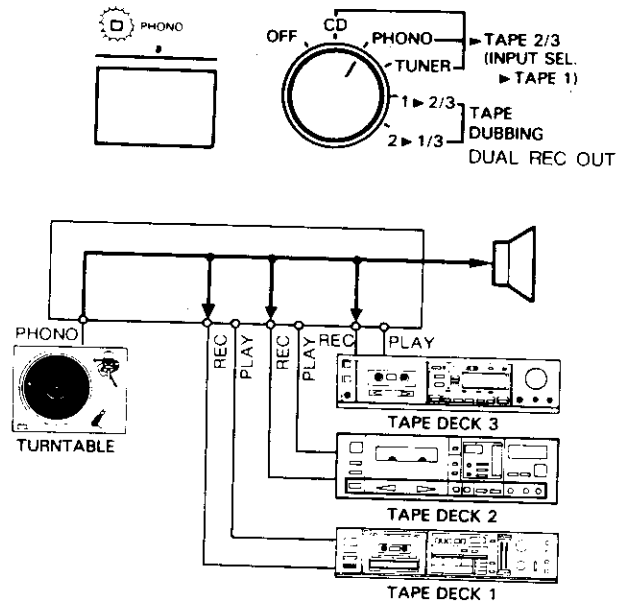

- Listening to CD player while dubbing from tape 2 to tape 1/3

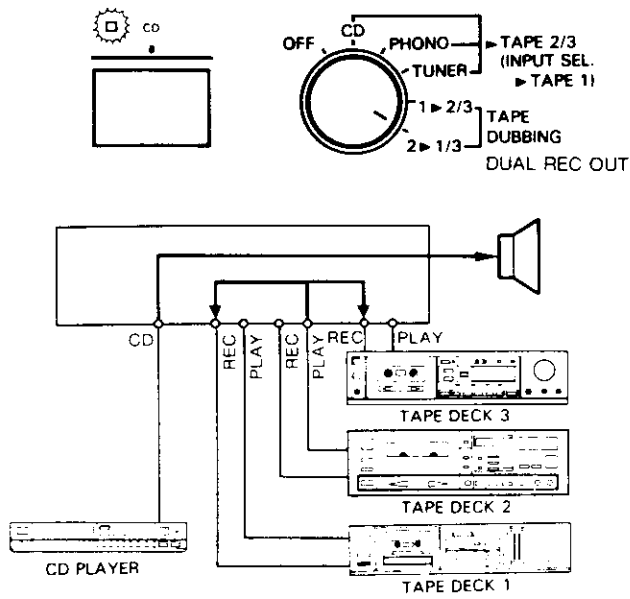

- Recording sound (from a video recorder, etc.) input from AUX jack at the same time as recording record play from a turntable on tape deck 2 or 3

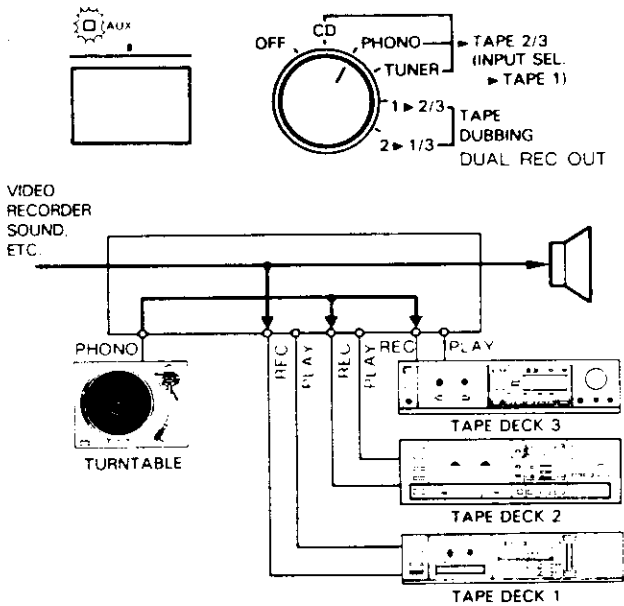

In case of difficulty

If your unit should not perform as expected, consult the table below to see if the problem can be corrected before seeking help from your dealer or service representative.

Troubles that occur when listening to AM/FM broadcasts and record play

Symptom	Possible cause	Remedy
Even when the POWER switch is set to "ON", the POWER indicator does not light nor sound is heard	The fuse may be blown.	Call your dealer or nearest service agent.
Sound is not heard from none of the speakers.	1. The SPEAKERS switch may be set to "OFF". 2. The speaker cable may be disconnected. 3. The VOLUME CONTROL may be set to (fully counterclockwise). 4. The DAT/TAPE MONITOR switch is depressed. 5. The CD DIRECT switch is set to ON.	1. Set to "A", "B", or "A + B". 2. Check the connection at the amplifier's output cable and at the terminals of the speaker boxes. 3. Turn the control clockwise for optimum volume. 4. Check that the DAT/TAPE MONITOR indicator is lit. When the DAT/TAPE MONITOR indicator is lit, press the DAT/TAPE MONITOR switch again so that the indicator goes off. 5. Set the switch to OFF.
Sound is not heard from one of the two speakers.	1. The speaker cable may be disconnected. 2. The BALANCE control may be set to the rightmost or leftmost ("R" or "L") position.	1. Check the connection at the amplifier's output cable and at the terminals of the speaker box. 2. Adjust the BALANCE control.

Troubles that occur only when listening to record play

Symptom	Possible cause	Remedy
When playing record, the audio volume is different from when listening to radio broadcasts	1. The tuner output level (for signal strength) may differ from the turntable output level. 2. The selection of the equalizer for MM or MC cartridge may be wrong.	1. Set the VOLUME CONTROL for optimum volume. 2. Set the CARTRIDGE switch (MM/MC) to suit the cartridge used.
No sound is heard from one or both of the speakers	The turntable's output cable may be disconnected.	Connect turntable's output cable securely into the PHONO terminals.
Low, low humming sound is heard or it is not heard	1. The turntable's output cable may be connected insecurely 2. The turntable's grounding wire may not be connected	1. Connect the turntable's output cable securely into the PHONO terminal. 2. Connect the turntable's grounding wire to the GND terminal on the amplifier's rear panel.
Low, hum noise is heard together with the music	The turntable's output cable may be passing near the power cord.	Correct the position of the turntable's output cable to minimize the hum noise. Inverse the left and right polarity of the insertion of the AC power cord.
Keen, squeaky noise is heard together with the music.	The turntable's output cable may be picking up noise from the television power source.	Correct the position of the turntable's output cable to minimize the noise.
When the volume is increased or bass sound is played, large howling sound is heard and no music is heard	The howling noise may be caused by the speaker vibrations transmitted to the turntable.	Install the turntable and speakers apart. Howling occurs more easily when the floor is soft. Check the installation of the speakers and correct if necessary.

Precaution

Speaker protection circuit

When this unit's power is turned ON with the speaker cable short-circuited, the speaker protection circuit functions.

In such case, even after the speaker circuitry has been restored for normal operation by eliminating the short-circuit of the speaker cable, the muting circuit still functions to cut the sound off. To stop its operation, turn power OFF then ON again. The POWER indicator will light.

Specifications

Power Output

80 watts per channel minimum RMS, both channels driven at 8 ohms from 20 Hz to 20,000 Hz with no more than 0.055% total harmonic distortion

Maximum Continuous Power Output (DIN) 1 kHz at 4 ohms	120 W
Maximum Continuous Power Output (IEC/NF) from 63 Hz to 12,500 Hz 0.7%	
Total Harmonic Distortion at 8 ohms	93 W + 93 W
Dynamic Power	190 W per channel at 4 ohms
Total Harmonic Distortion	
AUX input to SPEAKER output (20 Hz-20,000 Hz)	: 0.055% at 80 W into 8 ohms
Intermodulation Distortion (60 Hz:7 kHz = 4:1)	: 0.055% at 80 W into 8 ohms
Damping Factor	: 500 (50 Hz into 8 ohms)
Power Bandwidth	: 10 Hz to 45 kHz at 0.09% T.H.D. into 8 ohms
Frequency Response	: 5 Hz to 60 kHz/ +0 dB, -3 dB
Input Sensitivity/Impedance	
PHONO (MM)	: 2.5 mV/47 kohms
PHONO (MC)	: 0.2 mV/100 ohms
TUNER/AUX/TAPE	: 150 mV/47 kohms
Signal to Noise Ratio (IHF-A)	
PHONO (MM)	: 86 dB (2.5 mV)
PHONO (MC)	: 66 dB (0.2 mV)
TUNER/AUX/TAPE	: 108 dB (150 mV)
Signal to Noise Ratio Unweighted: 50 mW (DIN)	
PHONO (MM)	: 57 dB
TAPE/AUX/TUNER	: 58 dB
Phono Maximum Input Level	
(MM)	: 200 mV, (RMS) T.H.D. 0.055% at 1 kHz
(MC)	: 15 mV, (RMS) T.H.D. 0.055% at 1 kHz
Output Level/Impedance	
TAPE REC	: 150 mV/220 ohms
Phono Frequency Response	: RIAA standard curve ± 0.3 dB (20 Hz to 20 kHz)
Tone Control	
BASS (at 100 Hz)	: ± 10 dB
TREBLE (at 10 kHz)	: ± 10 dB
Loudness Control (at -30 dB Volume Level)	: 9 dB at 100 Hz
Subsonic Filter (at -3 dB)	: 6 dB/Oct. at 18 Hz

GENERAL

Power Consumption	: 4.2 A (U.S.A. and Canada Model) 260 W (Other Countries)
Dimensions	: W 440 mm (17-5/16") H 143 mm (5-5/8") D 343 mm (13-1/2")
Weight (Net)	: 9.2 kg (20.24 lb)

Note:

Our products are in continuous development. For this reason specifications may be changed without notice.